

Fit Guide
SS25



SS25

Les Deux

MEDITERRANEAN
SPORTS SOCIETY

A comprehensive range for Spring 25, and our interpretation of a trio of city styles. Rustic & unpretentious pieces inspired by Dubrovnik, sophisticated suiting elements meet '90s sportswear influenced by Naples, and NYC street & bro-core style is partnered with Ivy League prep. These three pillars are united throughout the range.

T-Shirts

Slim fit

Regular fit

Loose fit

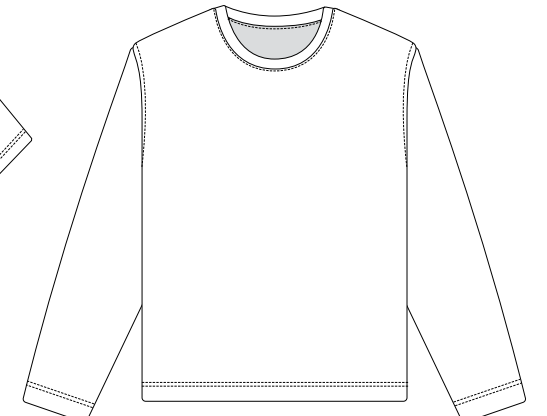
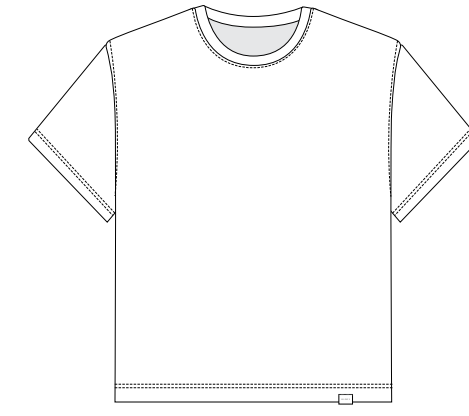
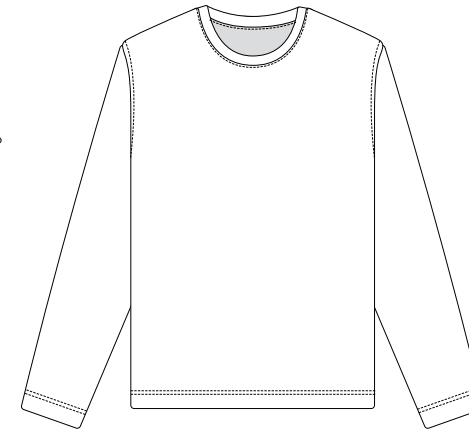
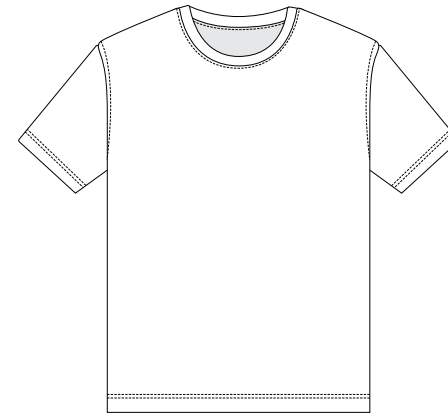
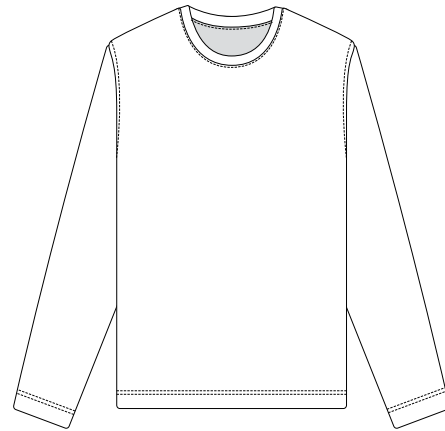
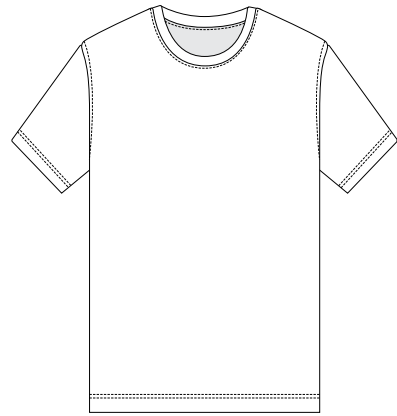
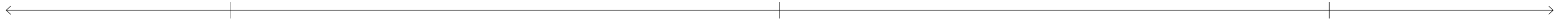

*Nørregaard Tonal T-Shirt
Piece T-Shirt*

*Dexter T-Shirt
Geoffroy T-Shirt
Mediterranean T-Shirt
Society T-Shirt
Pique Polo
Bruno T-Shirt
Atlas T-Shirt
Atlas LS T-Shirt
Axel Waffle Jersey Polo*

*Goods LS T-Shirt
Goods T-Shirt
Liberté T-Shirt
Crew T-Shirt
Cena T-Shirt*

T-Shirts

Slim fit

Regular fit

Loose fit

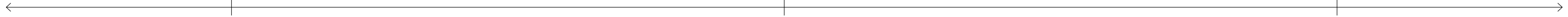

Model is wearing size M

Sweatshirts / Hoodies

Regular fit

Loose fit

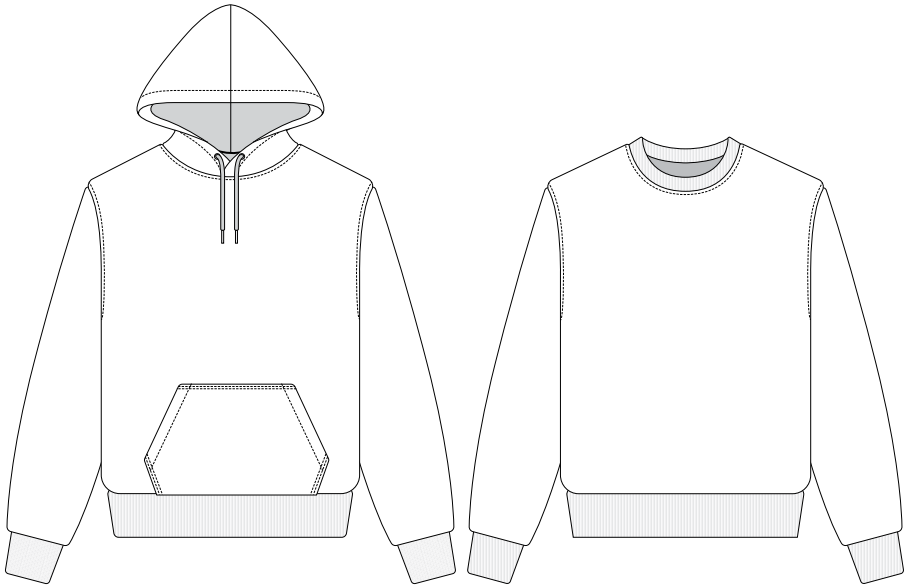

- Dexter Hoodie
- Dexter Sweatshirt
- Geoffroy Zipper Hoodie
- Geoffroy Zipper Polo Sweatshirt
- Mediterranean Sweatshirt
- Society Hoodie
- Society Sweatshirt
- Bruno Sweatshirt

- Good Hoodie
- Goods Sweatshirt
- Sully Patch SS Sweatshirt
- Sully Patch Sweatshirt
- Liberté Sweatshirt
- Crew Hoodie
- Crew Sweatshirt
- Cena Sweatshirt

Sweatshirts / Hoodies

Regular fit

Loose fit



Model is wearing size M

SS Shirts

Regular fit

Loose fit



- Lawson Stripe SS Shirt*
- Klark Stripe Poplin SS Shirt*
- Klark Denim SS Shirt*
- Kris Linen SS Shirt*
- Charlie SS Shirt*
- Kingsley AOE SS Shirt*



- Kamar AOP SS Shirt*
- Hendrix AOE SS Shirt*
- Hector Lace SS Shirt*
- Hector Anglaise SS Shirt*
- Foulard AOP SS Shirt*
- Lesley Flower Tile AOP SS Shirt*
- Lesley Ruins AOP SS Shirt*
- Hector Ruins Jacquard SS Shirt*

Shirts / Overshirts

Regular fit

Loose fit



- Kristian Linen B.D. Shirt*
- Konrad Oxford Shirt - Seasonal*
- Konrad Stripe Oxford Shirt*
- Kash Denim Shirt*
- Layton Denim Overshirt 2.0*
- Layton AOP Denim Overshirt 2.0*
- Layton Washed Denim Overshirt 2.0*
- Jaiden Ruins Jacquard Overshirt*
- Joseph Check Overshirt*
- Charlie LS Shirt*
- Shane Stripe Cotton Overshirt*
- Hamilton Overshirt*
- Kalen AOE Shirt*

- Kent Tencel Shirt*
- Kent Stripe Peached Poplin Shirt*
- Steven Stripe Denim Overshirt*

Hugh Overshirt 2.0

SS Shirts / Shirts / Overshirts

Regular fit

Loose fit



Model is wearing size M

Shorts

Regular fit

Loose fit

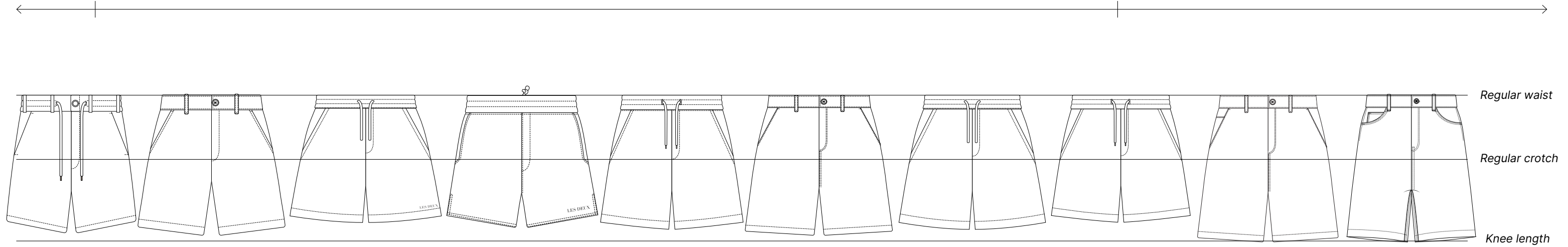

Como Slub
Drawstring Shorts

Como Reg Shorts
Como Reg
Herringbone Shorts

Lawson Stripe Shorts

Raphael Shorts 2.0

Otto AOP Shorts
Otto Linen Shorts
Otto Cotton Shorts
Otto Ruins Jacquard Shorts

Kody Cotton
Herringbone Shorts

Lesley Flower
Tile AOP Shorts

Charlie Shorts

Johnny Shorts

Ryder Canvas Shorts
Ryder Shorts
Ryder Washed Denim Shorts
Ryder AOP Denim Shorts

Pants (Slim / Regular fit)

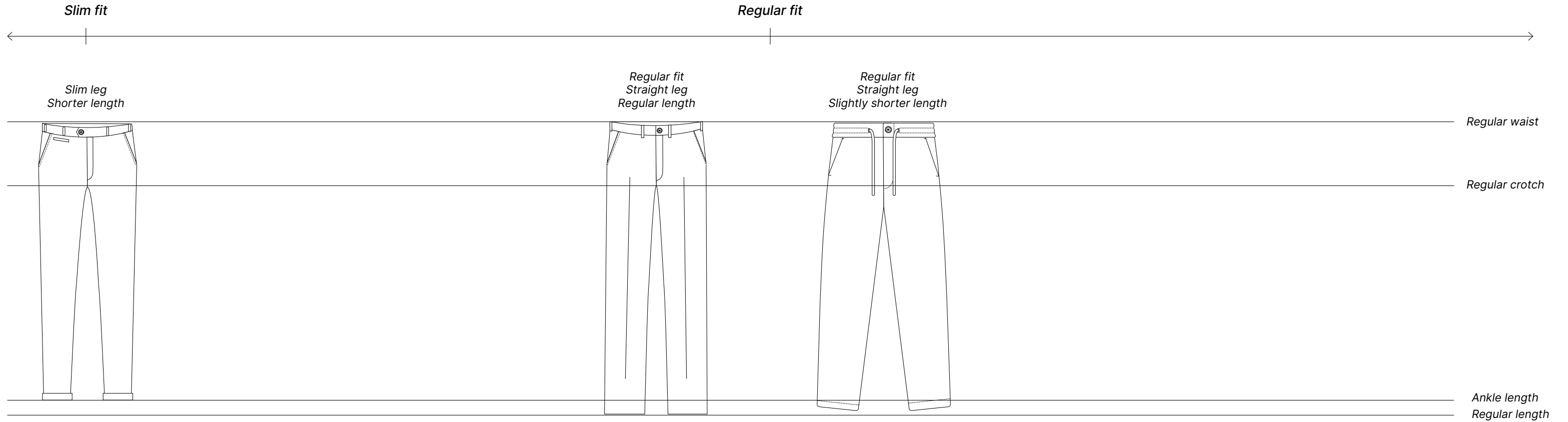

Como Suit Pants
Como Herringbone Suit Pants

Como Reg Suit Pants
Como Reg Herringbone Suit Pants
Como Tapered Drawstring Pants
Como Reg Texture Suit Pants

Como Tapered Drawstring Pants
Como Tapered Drawstring Pants_Seasonal
Como Tapered Textured Drawstring Pants
Como Tapered Slub Drawstring Pants

Pants (Loose fit)

Loose

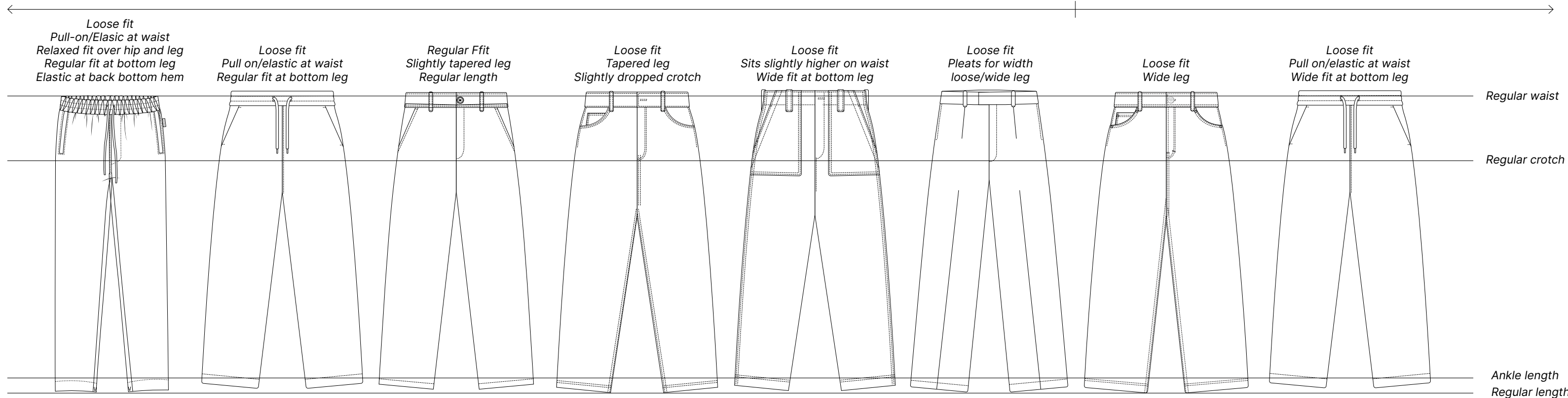

Sebastian Tech Pants

Patrick Linen Pants

Como Cotton Chino

Ryder Pants
Ryder Stripe Pants
Ryder Pants
Ryder Carpenter Pants
Ryder AOP Denim Pants
Kody Cotton Herringbone Pants

Lester Fatigue Pants

Reece Pleated Slub Suit Pants
Reece Pleated Pinstripe Suit Pants
Reece Pleated Check Suit Pants

Roi Denim Pants

Houston Stripe Cotton Pants

Pants

Slim fit

Regular fit

Loose fit

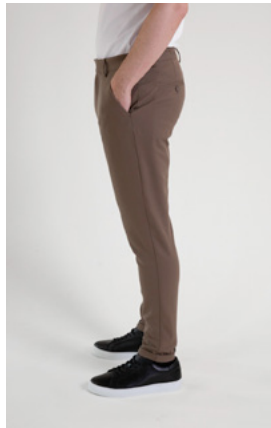
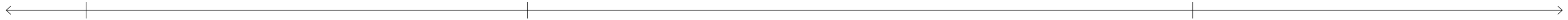

Model is wearing size 31

Model is wearing size 31

Model is wearing size 31

Model is wearing size 31

Model is wearing size 31

Model is wearing size 31

Model is wearing size M

Model is wearing size 31